

OWNER'S MANUAL

Operating and Servicing Instructions

Español - página E1



hoover.com

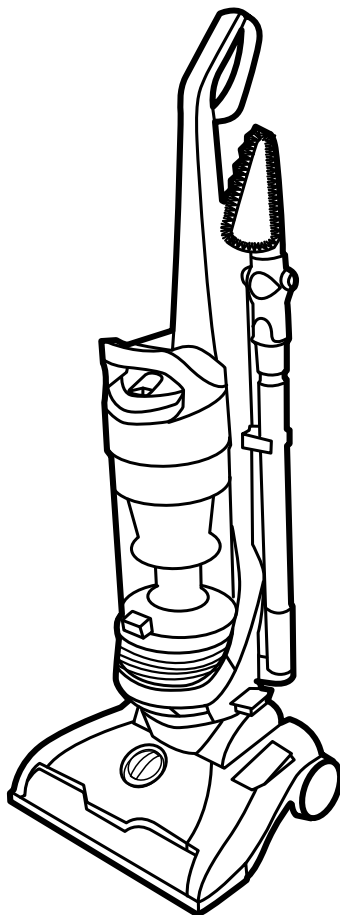

IMPORTANT: READ CAREFULLY BEFORE ASSEMBLY AND USE.

Questions or concerns? For assistance, please call Customer Service at 1-800-944-9200
Mon-Fri 8am-7pm EST. **PLEASE DO NOT RETURN THIS PRODUCT TO THE STORE.**

**THIS PRODUCT IS INTENDED FOR HOUSEHOLD USE ONLY.
IF USED COMMERCIALY WARRANTY IS VOID.**

Thank you for choosing a HOOVER® product.

Please enter the complete model and Manufacturing Code in the spaces provided.

MODEL _____

MFG. CODE _____

Hint: Attach your sales receipt to this owner's manual. Verification of date of purchase may be required for warranty service of your HOOVER® product.

Be sure to register your product online at Hoover.com or call 1-800-944-9200 to register by phone.



www.hoover.com
1-800-944-9200
(USA and Canada)

SAMPLE
X XXXXX XXXXX X

**Technronic Floor Care Technology Limited
VACUUM CLEANER/ASPIRATEUR/ASPIRADORA**
MODEL/MODELE/Modelo **XXXXXXXX**
MFG. CODE **XXXX**

SERIES/SERIE/SERIE XXXXX
HOUSEHOLD TYPE/TYPO MENAJER/TIPO DOMESTICO
Distributed by HOOVER, Inc. Glenwillow OH 44139
Made in China/Faço en China/Fabriqué en Chine



MANUFACTURING CODE
(Label located on bottom of vacuum)

CONTENTS

Important Safety Instructions	3
Vacuum Assembly	5
Carton Contents.....	5
Attach Handle.....	5
Position Tools	5
Attach Dirt Cup.....	5
How To Use	6
Vacuum Description.....	6
On-Off Switch.....	6
Cord Release	6
Carpet Height Adjustment.....	6
Suction Only Mode/ Brushroll Shut-Off	7
Tools	7
Select Proper Tool.....	7
Removing Hose	7
Attach Wand And Tools	7
Stair Cleaning.....	8
Cord Rewind & Storage	8
How To Clean Tools.....	8
Maintenance	8
Dirt Cup.....	9
Filters.....	9-10
Brushroll	11
Belt	12
Hose.....	13
Turbo Tool	13
Troubleshooting	14
Service.....	15
Warranty	16

If you need assistance:

Visit our website at hoover.com. Follow the authorized dealer locator link to find the Hoover® authorized dealer nearest you or call 1-800-944-9200 for an automated referral of Hoover® authorized dealer locations (U.S. only) or to speak with a customer service representative; Mon- Fri 8am- 7pm EST. **PLEASE DO NOT RETURN THIS PRODUCT TO THE STORE.**

IMPORTANT SAFETY INSTRUCTIONS

SAVE THESE INSTRUCTIONS

When using an electrical appliance, basic precautions should always be followed, including the following:

READ ALL INSTRUCTIONS BEFORE USING THIS APPLIANCE.

WARNING: TO REDUCE THE RISK OF FIRE, ELECTRIC SHOCK OR INJURY:

- Fully assemble before operating.
- Operate cleaner only at voltage specified on data label on bottom of cleaner.
- Do not leave appliance when plugged in. Unplug from outlet when not in use and before cleaning or servicing.
- Do not use outdoors or on wet surfaces.
- Do not allow to be used as a toy. Not intended for use by children age 12 and under. Close supervision is necessary when used near children. To avoid injury or damage, keep children away from product, and do not allow children to place fingers or other objects into any openings.
- Use only as described in this manual. Use only manufacturer's recommended attachments and products.
- Do not use with damaged cord or plug. If appliance is not working as it should, has been dropped, damaged, left outdoors, or dropped into water, take it to a service center prior to continuing use.
- Do not pull or carry by cord, use cord as a handle, close a door on cord, or pull cord around sharp edges or corners. Do not place product on cord. Do not run appliance over cord. Keep cord away from heated surfaces.
- Do not unplug by pulling on cord. To unplug, grasp the plug, not the cord.
- Do not handle plug or appliance with wet hands.
- Do not put any object into openings. Do not use with any opening blocked; keep free of dust, lint, hair, and anything that may reduce air flow.
- Keep hair, loose clothing, fingers, and all parts of body away from openings and moving parts. Brushroll continues to rotate when in the upright position.
- Turn off all controls before unplugging.
- Use extra care when cleaning on stairs. To avoid personal injury or damage, and to prevent the cleaner from falling, always place cleaner at bottom of stairs on floor. Do not place cleaner on stairs or furniture, as it may result in injury or damage.
- Do not use to pick up flammable or combustible liquids, such as gasoline, or fine wood sandings, or use in areas where they may be present.
- Hold plug when rewinding onto cord reel. Do not allow plug to whip when rewinding.
- Unplug before connecting Turbo Tool.
- Do not pick up anything that is burning or smoking, such as cigarettes, matches, or hot ashes.
- Do not use without dirt cup and/or filters in place.
- **WARNING:** This product contains chemicals known to the State of California to cause cancer, birth defects or reproductive harm. ***WASH HANDS AFTER HANDLING.***

CAUTION: TO REDUCE THE RISK OF DAMAGE:

- Avoid picking up hard, sharp objects with this product, as they may cause damage.
- Store appropriately indoors in a dry place. Do not expose machine to freezing temperatures.
- Brushroll continues to turn while product is turned on and handle is in upright position. To avoid damage to carpet, rugs, furniture and flooring, avoid tipping cleaner or setting it on furniture, fringed area rugs, or carpeted stairs during tool use.
- Do not use sharp objects to clean out hose as they can cause damage.
- With brushroll on, do not allow cleaner to sit in one location for an extended period of time, as damage to the floor can result.

WARNING:

- To reduce the risk of electric shock, this appliance has a polarized plug (one blade is wider than the other). This plug will fit in a polarized outlet only one way. If the plug does not fit fully in the outlet, reverse the plug. If it still does not fit, contact a qualified electrician to install the proper outlet. Do not change the plug in any way.

1. VACUUM ASSEMBLY

CARTON CONTENTS

- A. Handle*
- B. Vacuum Base
- C. Wand
- D. Crevice Tool
- E. Turbo Tool
- F. Adjustable Dusting Brush*
- G. (1) Large Screw
- H. Dirt Cup

*Varies per model.

Remove all parts from carton and identify each item shown.

Make sure all parts are located before disposing of packing materials.

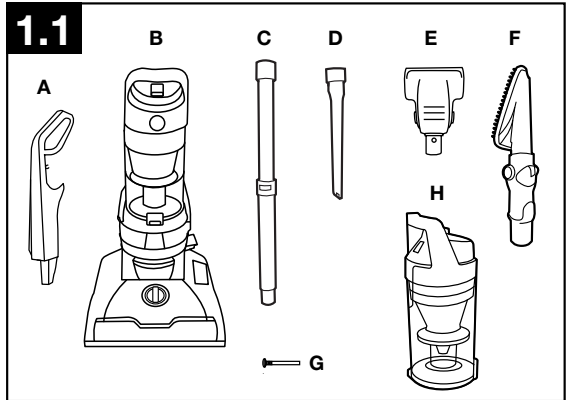

ATTACH HANDLE

1.2 Insert handle section into vacuum base. Push down firmly. Using a Phillips screwdriver, fasten (1) large screw behind handle into vacuum base.

1.3 Wrap hose around top of hose guide located on the handle. Insert the hose into hose tube until you hear a click.

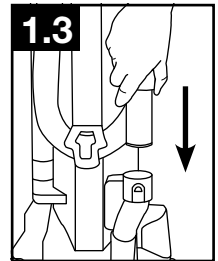
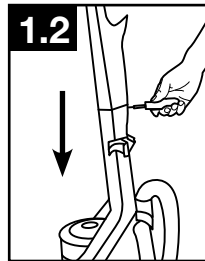

POSITION TOOLS

1.4 Place Crevice Tool into Wand and slide into tool storage area on left back side (C) of vacuum and place Turbo Tool on right back side (E) of vacuum as shown.

1.5 Place adjustable dusting brush (F) on top of wand.

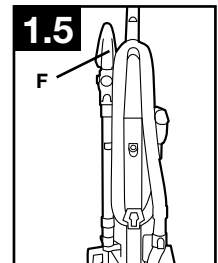
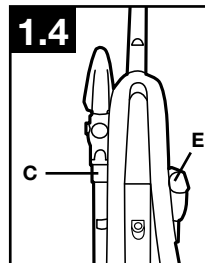

ATTACH DIRT CUP

1.6 Place bottom of dirt cup into vacuum body first. Pivot cup into vacuum. Dirt cup is secure when you hear a click.

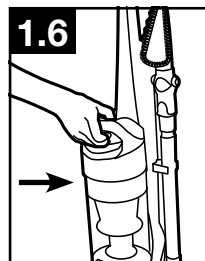

2. HOW TO USE

VACUUM DESCRIPTION

1. Handle
2. Dirt Cup Release Button
3. Carry Handle
4. System Check Indicator
5. Rinsable Filter Access
6. Dirt Cup
7. Filter made with HEPA media
8. Height Adjustment
9. Furniture Guard
10. Adjustable Dusting Brush
11. Wand
12. Crevice Tool (inside wand)
13. Cord Rewind Pedal
14. Brushroll ON/OFF Pedal
15. Handle Release Pedal
16. Hose
17. Turbo Tool
18. ON/OFF Switch
19. Hose Release Button
20. Hose Connecting Tube

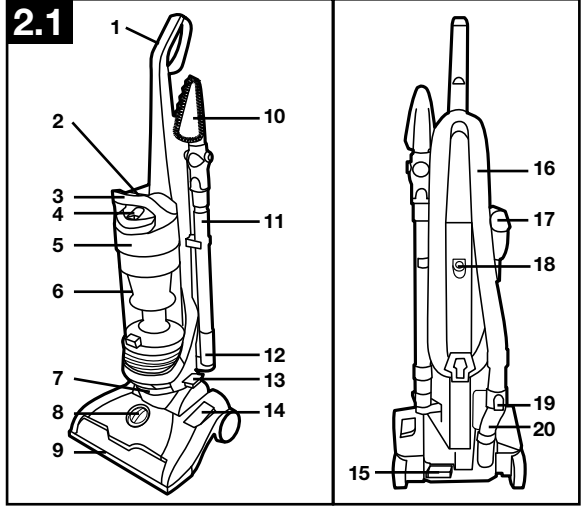

ON-OFF SWITCH

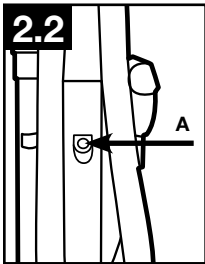

2.2 Plug cord into electrical outlet.

To turn vacuum ON (I=ON), push ON/OFF switch (A) to ON position.

To turn vacuum OFF (O=OFF), push switch to OFF position.

CORD RELEASE

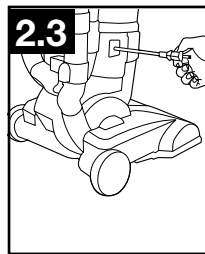

2.3 Prior to using, grasp the end of the plug and pull to release the cord from the cord reel until red tape is reached.

• IMPORTANT •

When pulling on the cord, yellow tape will identify when the cord is almost fully extended. When red tape is visible on the cord, the cord has reached its full length. **(Do not pull the cord past the red tape.)**

CARPET HEIGHT ADJUSTMENT*

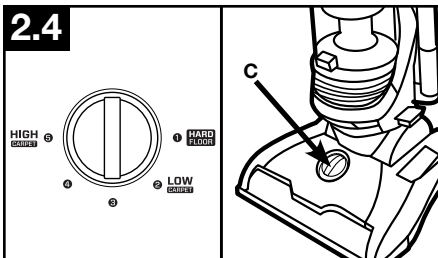

2.4 To adjust height setting, PUSH DOWN and TURN knob (C) to desired height setting.

For maximum cleaning performance, the following carpet height settings are recommended:

- Hard floor setting: for use on hard floors only.
- Low through High settings: Adjust depending on carpet type.
- For high pile carpet, use high carpet setting to ease pushing effort.

• IMPORTANT •

If the vacuum is difficult to push, push down and turn knob to the next higher setting.

*Number of height settings vary per model.

SUCTION ONLY MODE/ BRUSHROLL SHUT-OFF

for bare floors and very high pile carpet

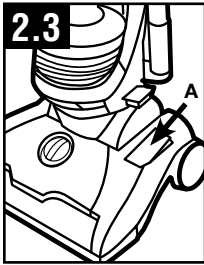

2.3 For optimal cleaning performance on bare floors and carpet with pile deeper than 1", brushroll should be turned off.

The vacuum is shipped with the brushroll in the ON position. To turn brushroll OFF for Suction Only Mode, step on pedal (A).

• IMPORTANT •

Pedal (A) is inactive when the cleaner is in the upright position.

⚠ CAUTION ⚠

Brushroll should be in off position for cleaning of high pile carpet deeper than 1".

⚠ CAUTION ⚠

Not to be used for grooming a pet.

3. TOOLS

Tools allow for cleaning surfaces above the floor and for reaching hard to clean areas.

The vacuum is ready for tool use when handle is in upright position.

• IMPORTANT •

Brushroll continues to turn while product is turned on and handle is in upright position. To avoid damage to carpet, rugs, furniture and flooring, avoid tipping cleaner or setting it on furniture, fringed area rugs, or carpeted stairs during tool use.

SELECT PROPER TOOL

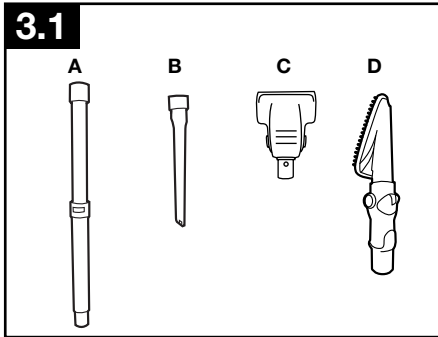

A. Wand is used to give extra length to your hose. Use it with any of the above tools.

B. Crevice Tool may be used in tight spaces, corners and along edges in such places as dresser drawers, upholstered furniture, stairs and baseboards.

C. Turbo Tool may be used for upholstered furniture, draperies, mattresses, clothing, and carpeted stairs.

D. Use Adjustable Dusting Brush to clean upholstered furniture, draperies, mattresses, clothing, carpeted stairs, light fixtures, and fans with 5 cleaning positions.

REMOVING HOSE

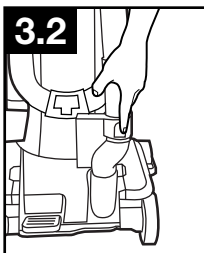

3.2 To remove hose for tool use, press the hose release button and pull hose end out.

To lock back into place, push hose into hose tube until you hear a click.

ATTACH WAND AND TOOLS

⚠ CAUTION ⚠

To reduce the risk of injury from moving parts - Unplug before servicing.

3.3

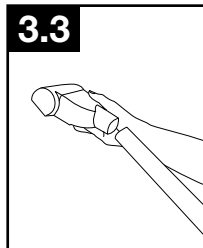

3.3 To attach tool or wand to hose, push firmly into place.

⚠ CAUTION ⚠

Not to be used for grooming a pet.

STAIR CLEANING

3.4 Use the Hose and Turbo Tool (Tool varies per model) for stair cleaning.

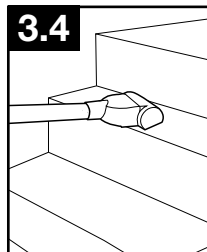

⚠ CAUTION ⚠

Use extra care when cleaning on stairs. To avoid personal injury or damage, and to prevent the cleaner from falling, always place cleaner at bottom of stairs on floor. Do not place cleaner on stairs or furniture, as it may result in injury or damage. When using tools, always ensure handle is in the upright position.

CORD REWIND AND STORAGE

3.5 To return cord for storage, hold plug and press down Cord Release Pedal (B) on side of cord reel.

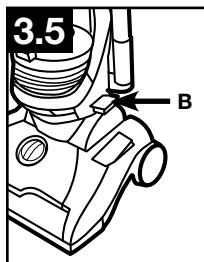

⚠ WARNING ⚠

Hold plug when rewinding onto cord reel. Do not allow plug to whip when rewinding.

HOW TO CLEAN TOOLS

To clean Hose and Turbo Tool, wipe with a damp cloth. DO NOT submerge in water.

Other cleaning tools may be washed in warm water with a detergent. Rinse and air dry 24 hours before using.

4. MAINTENANCE

Familiarize yourself with these home maintenance tasks as proper use and care of your vacuum will ensure continued cleaning effectiveness.

4.1 The System Check Indicator located at (A), alerts you to possible system performance issues.

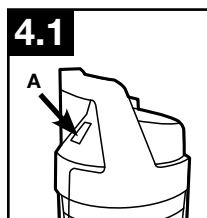

PROBLEM	POSSIBLE CAUSE	POSSIBLE SOLUTION
If System Check Indicator is red:	1. Rinsable filter and/or filter made with HEPA media is dirty.	1. Clean rinsable filter and/or filter made with HEPA media - reference pg. 9 and 10
	2. Dirt cup is full and/or clogged.	2. Empty dirt cup - reference pg. 9
	3. Cyclone filter assembly is clogged.	3. Clean cyclone filter assembly per pg. 10.

Any other servicing should be done by an authorized service representative.

If appliance is not working as it should, has been dropped, damaged, left outdoors, or dropped into water, take it to a service center prior to continuing use.

⚠ NOTICE ⚠

A Thermal Protector has been designed into your cleaner to protect it from overheating. When the thermal protector activates the cleaner will stop running.

If this happens proceed as follows:

1. Turn cleaner OFF and unplug it from the electrical outlet.
2. Empty dirt cup.
3. Inspect the nozzle inlet, hose connector, hose, dirt cup inlet, cyclonic filter, rinsable filter, and HEPA filter. Clear obstructions if present.
4. When cleaner is unplugged and motor cools for 30 minutes, the thermal protector will deactivate and cleaning may continue.

If the thermal protector continues to activate after following the above steps, your cleaner needs servicing.

DIRT CUP: When to Empty

4.2 To maintain optimal performance, empty the dirt cup before the dirt cup reaches the max line (B). Place the vacuum in the upright position before removing the dirt cup.

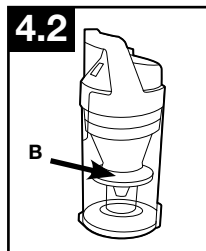

⚠ WARNING ⚠

To reduce the risk of personal injury - Unplug before cleaning or servicing. Do not use vacuum without dirt cup or filters in place.

Very fine materials, such as face powder or cornstarch, may seal the filter and cause a reduction in performance. When using the vacuum for this type of dust, empty the cup and clean the filters often.

How to Empty

4.3 Press dirt cup release button (C) and pivot cup out.

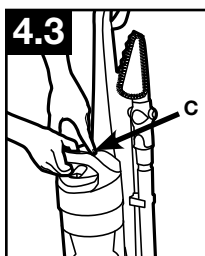

4.4 Hold dirt cup over trash receptacle, push dirt cup door release lever (D) to open dirt cup door (E).

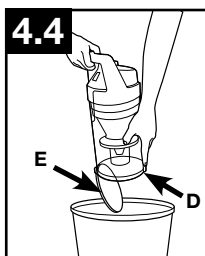

Close dirt cup door (E). Press firmly to secure.

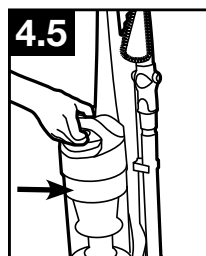

4.5 Place bottom of dirt cup into vacuum body first. Pivot dirt cup into vacuum body and press firmly until it locks into place.

FILTERS: When to Clean

To maintain optimal performance, filters should be cleaned at least every two months under normal use.

⚠ WARNING ⚠

To reduce the risk of personal injury - Unplug before cleaning or servicing. Do not use vacuum without dirt cup or filters in place.

Rinsable Filter: How to Clean

Remove dirt cup as described in Fig. 4.3.

4.6 Twist the dirt cup handle counterclockwise to open and remove lid.



4.7 Pull tab to remove rinsable filter.

Rinse with water for two minutes or until water runs clear. Then squeeze out excess water. Allow 24 hours for filter to dry completely.

Replace filter, tab side out.

4.8 Replace dirt cup lid and twist clockwise until locked in position.

Replace dirt cup as described in Fig 4.5.

• IMPORTANT •

Allow filter to dry completely before replacing. Dry filter on edge so air circulates on both sides of filter. This may take up to 24 hours.

4.8



What to Buy: Rinsable Filter

When used and maintained properly, your Rinsable Filter should not need replacement within the warranty period. If desired, additional filter is available at Hoover.com or call 1-800-944-9200. Ask for Hoover® Part No. 304087001.

Cyclonic Filter Assembly: How to Clean

⚠ WARNING ⚠

To reduce the risk of personal injury - Unplug before cleaning or servicing. Do not use vacuum without dirt cup or filters in place.

Do not use vacuum without dirt cup or filters in place.

Remove dirt cup and twist the dirt cup handle counterclockwise to open and remove lid as described in 4.6.

4.9 Pull filter assembly (G) out of dirt cup and remove.

4.10 Dirt and debris can be cleaned from the filter assembly with the adjustable dusting brush.

4.11 Place the filter assembly on the dirt cup. Line up tabs (H) on lid with dirt cup body.

4.12 Replace dirt cup lid and twist clockwise until locked in position.

Replace dirt cup as described in Fig 4.5.

4.9

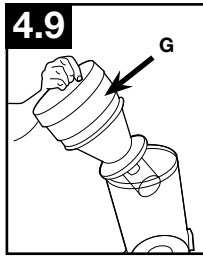

4.10

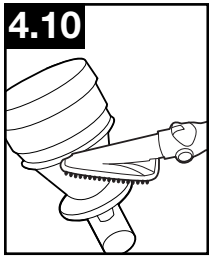

4.11



4.12

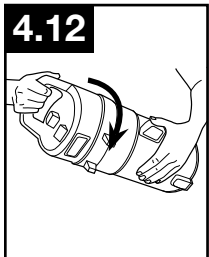

Filter Made With HEPA Media: How to Clean

4.13 With fingers under filter door lip, pull filter frame (A) out and away from vacuum body. Hold filter over a trash receptacle and tap out dirt and debris.

4.14 Bottom filter (B) must be pushed back into place first.

4.15 Then push the upper handle in (C) until it clicks.

4.16 Filter diagram: (B) bottom filter. (C) upper handle.

⚠ WARNING ⚠

To reduce the risk of personal injury - Unplug before cleaning or servicing. Do not use vacuum without dirt cup or filters in place.

4.13

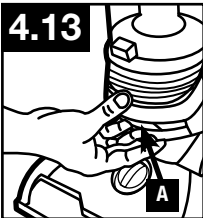

4.14

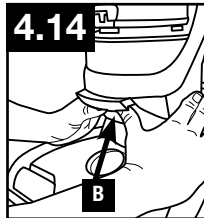

4.15

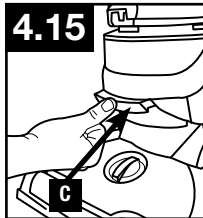

4.16

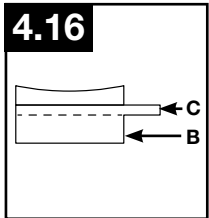

• IMPORTANT •

DO NOT RINSE OR WASH THE FILTER
MADE WITH HEPA MEDIA.

Filter Made With HEPA Media

When used and maintained properly, your Filter should not need replacement within the warranty period. If desired, additional filter is available at Hoover.com or call 1-800-944-9200. Ask for Hoover® Part No. 440005573.

BRUSHROLL: How to Clean

⚠ CAUTION ⚠

To reduce the risk of injury from moving parts - Unplug before servicing.

Brushroll - Bottom plate with screws

Place handle in the low position and turn the cleaner over so the bottom side is up.

4.17 Remove the 6 screws as shown with a Phillips screwdriver.

4.18 Pivot off bottom plate.

4.19 Remove any debris and/or hair from brushroll.

Replace the bottom plate aligning the screw holes and install the 6 screws as shown.

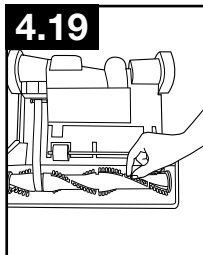
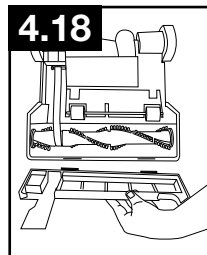
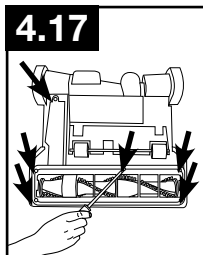

BELT



CAUTION

To reduce the risk of injury from moving parts - Unplug before servicing.

The belt is located under the bottom plate of the vacuum and should be checked from time to time to be sure it is in good condition.

When To Replace

Replace belt if it is damaged, cut or broken. Refer to directions below.

How To Replace - Bottom plate with screws

Place handle in the low position and turn the cleaner over so the bottom side is up.

4.20 Remove the 6 screws as shown with a Phillips screwdriver.

4.21 Lift off bottom plate (A).

4.22 Remove used belt from brushroll (C) then from motor shaft (metal rod) (D) and discard.

4.23 With lettering on outside of belt, slide new belt over motor shaft (metal rod) (E).

Then slip around area of brushroll without bristles (G).

4.24 With belt in place, pull and slide brushroll into nozzle making sure that the brushroll end caps are in the correct orientation.

Place the bottom plate aligning the screw holes and re-install the 6 screws.

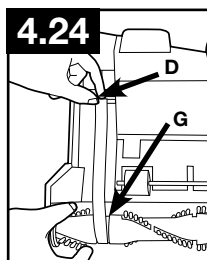
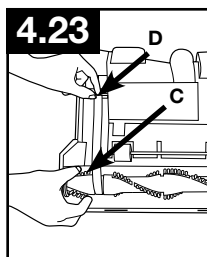
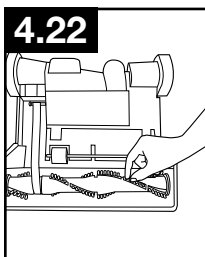
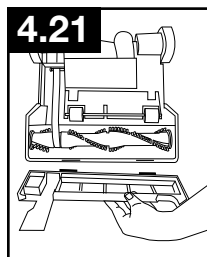
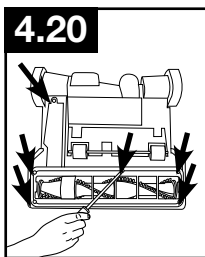

What to Buy: Belt

If desired, additional belts can be purchased at Hoover.com or 1-800-944-9200. When purchasing a new belt for models ask for Belt - HOOVER® part No. 562289001.

HOSE

⚠ WARNING ⚠

To reduce the risk of personal injury - Unplug before cleaning or servicing.

How to Clean

4.25 To remove hose for tool use, press the hose release button (A) and pull hose end out.

Clean away debris or obstructions from hose. Do not use sharp objects to clean out hose as they can cause damage. To lock back into place, push hose into hose tube until you hear a click.

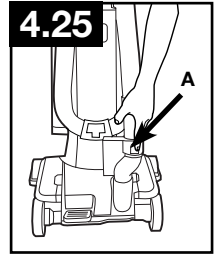

POWERED HAND TOOL: How to Clean

(Tool varies per model)

⚠ CAUTION ⚠

To reduce the risk of injury from moving parts - Unplug vacuum before servicing.

4.26 Clean the Turbo Tool by removing the two screws (A), located on the bottom cover, with a Phillips head screwdriver.

4.27 Remove the bottom cover (B).

Clean out any debris or hair from the brushroll and turbine fan.

4.28 Replace the bottom cover, insert and tighten the (2) screws.

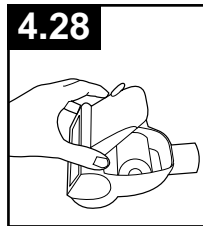
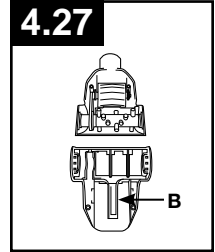
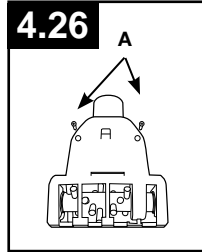

LUBRICATION

The motor and brushroll are equipped with bearings which contain sufficient lubrication for their lifetime.

The addition of lubricant could cause damage. Do not add lubricant to motor or brushroll.

5. TROUBLESHOOTING

If a minor problem occurs, it usually can be solved quite easily when the cause is found by using the checklist below.

Any other servicing should be done by an authorized service representative.

If appliance is not working as it should, has been dropped, damaged, left outdoors, or dropped into water, take it to a service center prior to continuing use.

⚠ WARNING ⚠

To reduce risk of personal injury - Unplug before cleaning or servicing.

PROBLEM	POSSIBLE CAUSE	POSSIBLE SOLUTION
Vacuum won't run	1. Power cord not firmly plugged into outlet.	1. Plug unit in firmly.
	2. Blown fuse or tripped breaker.	2. Check fuse or breaker in home. Replace fuse/reset breaker in home.
	3. Thermal Protector activated.	3. Unplug and allow vacuum to cool for 30min. (This will reset the thermal protector)
System Check Indicator has turned red or Vacuum won't pick up or Low suction	1. Rinsable Filter and/ or Filter made with HEPA media is dirty.	1. Clean Rinsable Filter and or Filter made with HEPA media - Pg. 9 and 10.
	2. Dirt cup full and/ or clogged.	2. Empty dirt cup - Pg. 9.
	3. Broken or worn belt.	3. Replace belt - Pg.12.
	4. Brushroll and/ or Hose clogged.	4. Check Hose - Pg. 13. Check Brushroll - Pg. 11.
	5. Carpet height setting is incorrect.	5. Set Carpet Height Adjustment to appropriate setting for carpet being cleaned - Pg.6.
Cord Rewind does not work	1. Cord reel does not retract.	1. Call 1-800-944-9200 for the nearest authorized service representative
Dust escaping from vacuum	1. Dirt cup full.	1. Empty dirt cup - Pg. 9.
	2. Dirt cup not installed correctly.	2. Review Dirt Cup removal & replacement - Pg. 9.
	3. Hose not installed correctly.	3. Review Hose installation - Pg. 7.
	4. Rinsable and/ or Filter made with HEPA media not installed completely.	4. Review Filter Removal and Cleaning - Pg. 9 and 10.
Vacuum is difficult to push or won't move forward	1. Carpet height setting is incorrect.	1. Set Carpet Height Adjustment knob to appropriate setting for carpet being cleaned - Pg. 6.
Turbo Tool brushroll won't turn	1. Too much pressure being applied to tool.	1. Continue using tool applying light pressure.
	2. Blockage.	2. Remove blockage - Pg. 11
	3. Low vacuum suction.	3. Check items under "Vacuum won't pick or Low suction."
Smoky/burning smell detected	1. Belt broken or stretched.	1. Replace brushroll belt - Pg. 12.
	2. Brushroll is clogged.	2. Clear/ remove debris from brushroll - Pg. 11.

6. SERVICE

To obtain approved Hoover® service and genuine Hoover® parts, locate the nearest Authorized Hoover® Warranty Service Dealer (Depot) by:

- Checking the Yellow Pages under “Vacuum Cleaners” or “Household”.
- Visit our website at hoover.com (U.S. Customers) or hoover.ca (Canadian customers).

Follow the service center link to find the service outlet nearest you.

- For an automated referral of authorized service outlet locations call 1-800-944-9200.

Do not send your vacuum to Hoover®, Inc., Company in Glenwillow for service. This will only result in delay.

If you need further assistance:

To speak with a customer service representative call 1-800-944-9200; Mon-Fri 8am-7pm EST. Always identify your vacuum by the complete model number when requesting information or ordering parts. (The model number appears on the bottom of the vacuum.)

PLEASE DO NOT RETURN THIS PRODUCT TO THE STORE.

7. WARRANTY

LIMITED THREE YEAR WARRANTY

(Domestic Use)

WHAT THIS WARRANTY COVERS

When used and maintained in normal household use and in accordance with the Owner's Manual, your HOOVER® product is warranted against original defects in material and workmanship for a full two year from date of purchase (the "Warranty Period"). During the Warranty Period, Hoover® will provide labor and parts, at no cost to you, to correct any such defect in products purchased in the United States, U.S. Military Exchanges and Canada.

HOW TO MAKE A WARRANTY CLAIM

If this product is not as warranted, take or send the product to either a Hoover® Authorized Warranty Service Dealer along with proof of purchase. For an automated referral to authorized service outlets in the U.S.A., phone: 1-800-944-9200 OR visit Hoover® online at www.hoover.com. For additional assistance or information concerning this Warranty or the availability of warranty service outlets, phone the Hoover® Consumer Response Center, Phone 1-800-944-9200, Mon-Fri 8am-7pm EST.

WHAT THIS WARRANTY DOES NOT COVER

This Warranty does not cover: use of the product in a commercial operation (such as maid, janitorial and equipment rental services), brushroll, belt, improper maintenance of the product, damage due to misuse, acts of God, nature, vandalism or other acts beyond the control of Hoover®, owner's acts or omissions, use outside the country in which the product was initially purchased and resales of the product by the original owner. This warranty does not cover pick up, delivery, transportation or house calls. However, if you mail your product to a Hoover® Authorized Warranty Service Dealer, cost of shipping will be paid one way.

This warranty does not apply to products purchased outside the United States, including its territories and possessions, outside a U.S. Military Exchange and outside of Canada. This warranty does not cover products purchased from a party

that is not an authorized retailer, dealer, or distributor of Hoover® products.

OTHER IMPORTANT TERMS

This Warranty is not transferable and may not be assigned. This Warranty shall be governed and construed under the laws of the state of Ohio. The Warranty Period will not be extended by any replacement or repair performed under this Warranty.

THIS WARRANTY IS THE EXCLUSIVE WARRANTY AND REMEDY PROVIDED BY HOOVER®. ALL OTHER WARRANTIES, EXPRESSED OR IMPLIED, INCLUDING WARRANTIES OF MERCHANTABILITY OR FITNESS FOR PARTICULAR PURPOSE, ARE DISCLAIMED. IN NO EVENT WILL HOOVER BE LIABLE FOR ANY SPECIAL, INDIRECT, INCIDENTAL OR CONSEQUENTIAL DAMAGES OF ANY KIND OR NATURE TO OWNER OR ANY PARTY CLAIMING THROUGH OWNER, WHETHER BASED IN CONTRACT, NEGLIGENCE, TORT OR STRICT PRODUCTS LIABILITY OR ARISING FROM ANY CAUSE WHATSOEVER. Some states do not allow the exclusion of consequential damages, so the above exclusion may not apply to you. This warranty gives you specific rights; you may also have others that vary from state to state.